



USER INFORMATION

WWW.PACIFICHELMETS.COM
SALES@PACIFICHELMETS.COM



Pacific Helmets NZ Ltd

P.O. Box 866 / 315 Heads Road

Wanganui 4501, New Zealand

Phone: +64 6 344 5019

Fax: +64 6 344 5376

Email: sales@pacifichelmets.com

Website: www.pacifichelmets.com

F15 USER INFORMATION

CONTENTS

- 4 **Please Read Before Use**
 - 5 Introduction
 - 6 Warnings
 - 7 General Pre-Use Information
- 11 **F15 Summary**
 - 12 Overview of the F15
 - 14 Parts
- 16 **Setting Up Your Helmet**
 - 17 Preparation For Use
 - Fitting Your Helmet*
 - Eye Protector Instructions*
 - 27 Fitting Accessories
 - 29 Wearing Instructions
 - Donning*
 - Doffing*
 - Recommended Storage Practices*
- 31 **Care & Maintenance**
 - 32 Details of Inspections
 - 33 Care and Maintenance Instructions
 - Cleaning and Disinfection Precautions*
 - Routine Cleaning and Disinfection*
 - Optional Machine Washing of Selected Components*
 - Decontamination*
 - 37 Repair, Replace, and Obsolescence Instructions
- 39 **Warranty**
 - 40 Warranty Information
- 42 **Technical Information**
 - 43 Certification And Distributors Information
 - 44 Standards Information
 - AS/NZS4067:2012*
 - EN443:2008 / CE / MED*
 - NFPA1971:2018 and*
 - NFPA1951:2020*



**PLEASE READ
BEFORE USE**

INTRODUCTION

This guide addresses the model F15 Structural Firefighting Helmet by Pacific Helmets NZ Ltd.

Your new helmet incorporates materials and design ideas that are primarily intended to safely protect you from all foreseeable dangers and to give the best possible comfort, convenience and appearance that a modern protective helmet can provide depending on the standard. We have selected the best possible material fit for the intended purposes, carefully engineered and manufactured the helmet to precise design and performance criteria. Your helmet will provide protection to your head and portions of your face and neck as part of a properly selected and configured ensemble.

This guide provides information and instructions related to the selection, use, care, and maintenance of your helmet. However, this guide does not tell you when and under what circumstances you should wear your helmet. Rather, it suggests how to properly wear your helmet and provides an understanding of the limitations of your helmet in how it may or may not protect you. The responsibility for determining the suitability of your helmet for specific emergency operations rests with your department or employer, who has the legal responsibility to conduct a risk assessment and decide if your helmet provides appropriate protection against identified hazards.

IMPORTANT NOTICE



This user information is to be removed from the helmet only by the end user. Please read carefully all instructions and warnings before use. Failure to follow these instructions could result in death or serious injury.

WARNINGS



The helmet is designed to absorb shock by partial destruction of, or damage to, the shell and liner. This damage may not be visible. If subject to severe impact or deterioration, the helmet is to be inspected, or replaced, even if it is apparently undamaged.



This helmet is not designed to provide protection from the following hazards: non-ionizing radiation, ionizing radiation, CBRN, explosions, and gun shots.



The length of the usable life of this helmet will be affected by the type(s) of material used in its construction and the environment in which the helmet is used and stored. Recommendations on this topic should be sought from the manufacturer.



The safety intended to be provided by the helmet can only be ensured when it is properly assembled and correctly fitted, and that removable parts shall not be worn separately.



When fitted with another item of personal protective equipment or with an accessory (other than those supplied by Pacific Helmets (NZ) Ltd for use with this helmet), a helmet marked as complying with EN443 might no longer satisfy all clauses of the standard. *Applies to EN443 certified helmets only.*



This helmet complies with the retention requirements of EN443 when the chinstrap supplied by the helmet manufacturer is worn and adjusted in accordance with these instructions. *EN443 certified helmets only.*

GENERAL PRE-USE INFORMATION

It is critically important that you do not use your protective helmet until you have read and understood this entire guide and the labels provided on the interior of your protective helmet. In order to reduce, but not eliminate, your risks. **Do not wear this protective helmet unless the following are understood.**

- i. **For NFPA users, you have read, fully understand, and strictly adhere to the following:** this guide and all labels for this helmet; NFPA1971, *Standard on Protective Ensembles for Structural Firefighting and Proximity Firefighting*; NFPA1951, *Standard on Selection, Care, and Maintenance of Protective Ensembles for Structural Firefighting and Proximity Firefighting*; and applicable national, state/provincial, and local regulations pertinent to emergency operations.
- ii. **For NFPA users:** your use of this protective helmet is consistent with NFPA1500, *Standard on Fire Department Occupational Safety and Health, and Wellness Program*, Title 29, Code of Federal Regulations Part 1910.132 and General Requirements of Subpart I, "Personal Protective Equipment."
- iii. **The labels, this guide and applicable standards and regulations:** You have read, fully understood, and will strictly adhere to this guide, all labels for this helmet and applicable national, state/provincial and local regulations pertinent to emergency operations.
- iv. **Your use is in accordance with applicable standards and regulations:** Your use of the helmet is consistent with the relevant standards and regulations governing the applications in which the helmet is being used.

- v. **Hazard/risk assessment already conducted:** Your department, organization, or employer has conducted a risk/hazard assessment and determined that this helmet provides an acceptable level of protection for the particular emergency operations consistent with applicable federal, state/provincial, and local regulations.
- vi. **Your helmet is properly adjusted:** Your helmet must fit or be adjusted to the size of your head. Where applicable, it also should be positioned to not interfere with your Self-Contained Breathing Apparatus (SCBA) full face piece.
- vii. **All components of your helmet are in place and properly worn:** Your helmet must be complete and you must wear your helmet properly. Where applicable, this includes the full deployment of your neck protector and the proper attachment and adjustment of your chinstrap for securing the helmet on your head.
- viii. **Limitations of protection:** You have been trained and understand that not all helmets provide heat and/or flame resistance or protection from all hazards, and you have been trained and understand how to select and properly use the appropriate helmet to meet the expected exposure.
- ix. **Risks of heat stress:** It is possible that wearing your protective helmet together with other ensemble elements may increase your risk of heat stress, which may cause heart attack, stroke, dehydration, or other health-related conditions. At the first sign of heat stress, immediately seek medical help.
- x. **Risks of burn injury:** Your protective helmet will not protect you from all burns and injuries. If your protective helmet is exposed to radiant, convective, or conductive heat, or comes in contact with a hot environment or hot object, you may be burned underneath

the protective helmet with no warning and no sign of damage to the protective helmet.

- xi. **Possibility that heat sensation may be absent:** Be aware your protective helmet will lower your ability to feel heat. Do not be misled by the absence of heat or discomfort underneath your protective helmet. Even though you do not feel heat or discomfort, you can be burned or injured suddenly and without warning. If you feel heat or some slight discomfort or unusual sensation under your protective helmet, you may already have been burned or are about to be burned. Be constantly alert to the possibility of exposure to heat and other hazards.

- xii. **Other hazards:** Your protective helmet, wet or dry, may not offer complete protection from electrical shock. It will not protect you from all physical hazards. Heavy falling objects or impact with hard surfaces involve forces that can be fatal or severely injure you. Do not use your protective helmet if it is contaminated, cut, punctured, worn, cracked, abraded, or altered from its original conditions.

- xiii. **The need for complete ensemble:** This helmet is effective only when it is properly worn; provides a proper interface with your garment, hood, and SCBA; and is part of a complete ensemble. A complete ensemble includes appropriate elements for your overall protection and is consistent with your organization / department's hazard/risk assessment.

- xiv. **Proper care and maintenance:** This helmet must be properly inspected, maintained, and cared for by your department, organization, or employer consistent with these instructions and applicable federal, state/provincial, and local regulations. It must be free of soiling, contamination, damage, and any alteration from its original condition that would compromise its protection. Damage and contamination of this helmet may warrant its disposal.

- xv. **Replacement after impact or high heat exposure:** Your helmet is made to absorb the energy of a blow by partial destruction or damage to the shell and/or suspension system. Even though such damage may not be readily apparent, you should replace your helmet if it is subjected to a severe impact or excessive heat.
- xvi. **Warranty:** This helmet is NOT warranted to be fit for a particular purpose. Read carefully the “Warranty Information” in this user information. If labels in the helmet are missing or become unreadable, contact the manufacturer for replacement labels.
- xvii. **Marking recommendations and modifications:** Do not attempt to alter or modify your helmet. Do not paint or apply any materials to the exterior of the helmet that have not been approved by Pacific Helmets. For identification purposes, you may mark your protective helmet on the interior using an indelible marker, if permitted by your department or organization. Do not write over or obscure information on the product label.
- xviii. **Testing and assessment of performance:** Your protective helmet has been evaluated for a number of performance properties that are based on the respective standard(s) for its certification. These properties include, but are not limited to, impact resistance and force acceleration, physical penetration resistance, heat and thermal shrinkage resistance, flame resistance, electrical insulation, retention system strength, suspension system retention. Where required by the relevant standards, helmets may also be checked for shell separation, label durability and legibility, corrosion resistance, and trim visibility. If you have any questions, check with your department or organization, who in turn can contact Pacific Helmets for clarification.



F15 SUMMARY

OVERVIEW OF THE F15

Standard components available on the F15 helmet. Please note, configuration is customisable and some features may differ.

1. Reflective Trim
2. Kevlar® & Fibreglass Reinforced Composite Shell
3. Advanced Polymer Chassis
4. Adapter Plates
5. Rear Storage Hanger
6. Flame and Heat Resistant Neck Protector
7. Pivot Headband
8. Front Plinth
9. Eye Protector
10. Dual Pivot Face Shield
11. Polyurethane Impact Liner
12. Micro-Flex Hinge
13. Hands-Free Comms Bracket
14. 6-Point Ribbon Suspension System with Padded Air Mesh
15. 4-Point Nomex® Chinstrap
16. Quick Release Buckle

TECHNICAL DATA

Helmet Size: **One Size Fits All.** Ratchet adjustable headband for head sizes between 52-65cm. Downsize padding available for smaller head sizes.

Certified:

- **AS/NZS 4067:2012** with AS/NZS 1337.1:2010
- **EN443:2008** with EN14458:2004
- **Dual Certified to NFPA 1971:2018 and NFPA 1951:2020** with ANSI Z87.1:2015

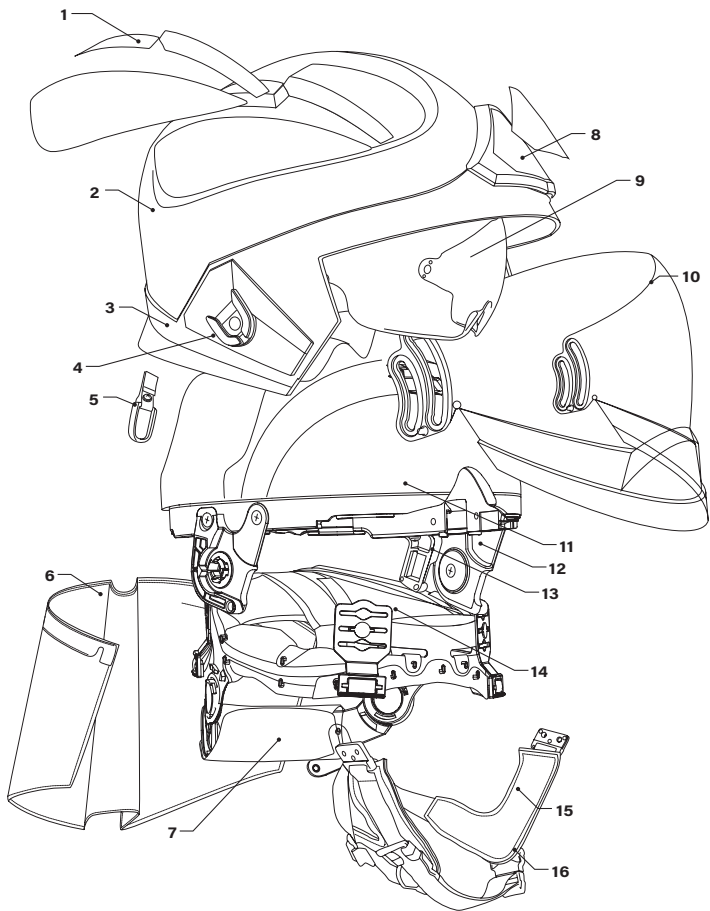

PARTS

Details of current accessories and spare parts approved by the manufacturer.

FEATURES AND ACCESSORIES *

- Shell:**
 - Painted Shell with Chassis
- Front Plinth:**
 - Standard Plinth
- Reflectors and Decals:**
 - 3M680 Trim Range
 - 3M8887 Trim Range

*Custom reflector shapes available by request.
Reflector options are standard dependent.*
- Adapter Plates:**
 - Easi-On-Off Base
 - SCBA / Easi-On-Off Base Combo
- Liner:**
 - PU Liner/Headband/Air Mesh
 - *Headband and Air Mesh Only*
 - *Liner Retainer Set*
- Chinstrap:**
 - 4-point Nomex® Chinstrap
 - *Screw Set for Chinstrap*
- Eye Protector:**
 - OTEP™ V3 Eye Protector
 - *OTEP™ Hinge Kit*
- Face Shield:**
 - Clear Face Shield
 - Gold Plated Face Shield
 - *Glides Kit for Face Shield*

FEATURES AND ACCESSORIES *

Neck Protector: • Short Gusseted, Long Gusseted, and Wrap Styles available in:

- *Black Nomex®*
- *Yellow Nomex®*
- *Yellow FR Fabric*
- *Aluminized/Black Nomex®*

Custom Neck Protectors may be available by request. Neck Protector options are standard dependent.

Rear Hanger: • Rear Hanger

- *Screw Set for Rear Hanger*

Lighting: • UK3AA eLED Tail Switch Torch

- *Torch Clip Pair for UK3AA*
- Adaro Adalit L5 Torch
 - *Torch Clip for Adaro*
- UK3AAA eLED Vizion I Lamp
 - *F15 Vizion Plinth*

Comms System: • Titan® Comms Bracket

- Titan® Comms with Push to Talk (PTT) Option

Sizing: • Downsize Padding for 50-56cm

** Including but not limited to, subject to change. Some options are standard dependent. Spare parts and accessories may not be compatible with your exact build of F15, please contact your distributor for more information.*



NOTE: it is important to consult with the distributors/ manufacturer for any accessories not listed in the above table before using them with your protective helmet to avoid invalidating the helmet's certification or causing unintended consequences which might involve injuries or even death.



SETTING UP YOUR HELMET

PREPARATION FOR USE

FITTING YOUR HELMET

The integrity, fit, and proper assembly of the helmet, suspension, and chinstrap must be checked before each use. Your safety depends upon the proper fit of your helmet and proper use of all features and components.

All adjustments are independent of how far your head goes into the helmet and do not affect the length of the overhead suspension ribbons.

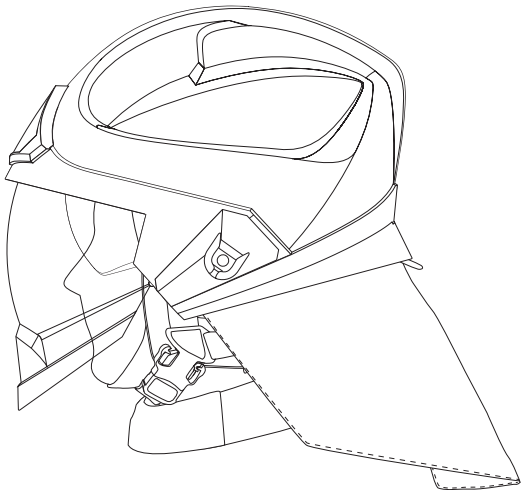

REMOVE PACKAGING

Remove the vinyl protective film from the face shield and/or eye protector and remove user information from inside helmet before use. Protective films can be disposed of.

FIT THE HELMET TO YOUR HEAD

The chinstrap and headband should be adjusted to a point where it is comfortable to wear but does not allow the helmet to move or wobble.

1. **Loosen the two rear adjustment points.** Loosen the two rear adjustment straps by lifting the rear ladder lock and pulling on the webbing strap with the other hand.
2. **Undo the chinstrap and loosen the under chin strap.** Hold the fixed end of the under chin strap and pull on the buckle to loosen the under chin strap.
3. **Put the Helmet on and do up the buckle.** Pull the free end of the strap under your chin until secure. This should be fitted firmly but does not need to be so tight as to cause discomfort.

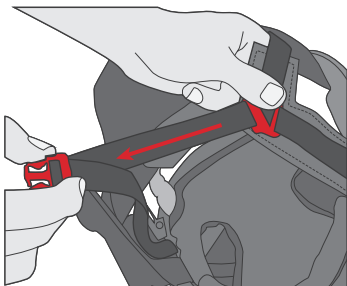
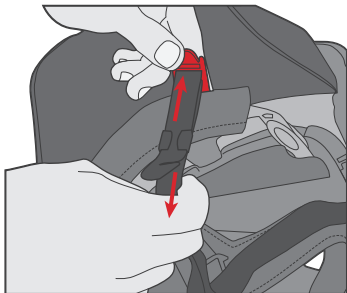

4. **Rotate the ratchet control knob anti-clockwise to expand or clockwise to contract the headband to provide comfortable but firm fit to the head.** Do not overtighten the ratchet. The headband fits a nominal range of head sizes from 52 to 65cm.

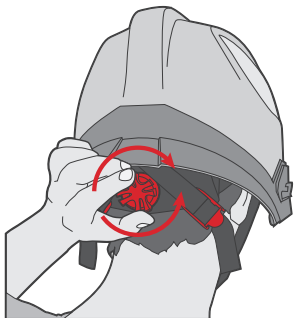

5. **Adjust the two rear nape straps.** Pull the free ends of the two rear adjustment straps with the helmet still on your head to the correct tightness.



6. **Readjust if required.** Always make sure the nape strap connectors with the chinstrap rest under both the ears and with the nape strap pulled tight before pulling the chinstrap firm under the chin. Secure loose ends of chinstrap to the velcro.

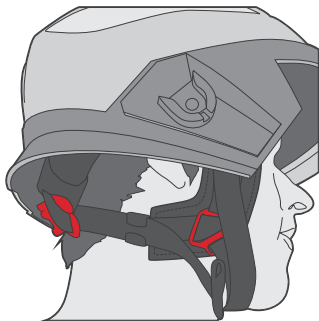

ADJUSTING THE HEADBAND HEIGHT (OPTIONAL)

There are three levels of wearing height for the headband. Your helmet comes preset at the mid height which will suit the majority of wearers.

For smaller head sizes adjust the headband to allow your head to sit deeper inside the helmet, and vice versa for larger head sizes.

- 1. Detach Cradle Hanger (B) from Liner (A).** Remove the cradle hanger from the liner slot by pulling upwards on the ribbon (C).
- 2. Detach Headband (D) from Cradle Hanger (B).** Disengage the headband boss by bending the cradle hanger to enable the boss to pop free.
- 3. Reattach Headband (D) to Cradle Hanger (B).** Reattach the boss on the required level by sliding the boss into the cradle hanger on one edge with the cradle hanger bending, then slide the other side of the boss in.
- 4. Reattach Cradle Hanger (C) to Liner (A).** Push the cradle hanger back into the liner slot firmly. Repeat for all 4 cradle hangers.

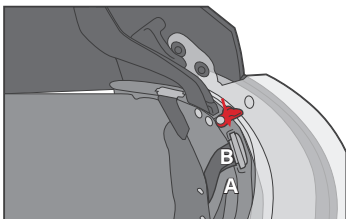
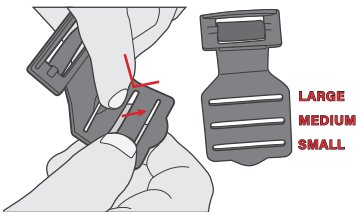
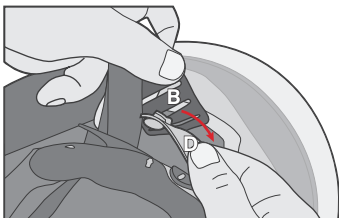
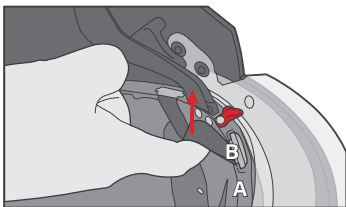

EYE PROTECTOR INSTRUCTIONS

ONE TOUCH EYE PROTECTOR™ (OTEP)

DEPLOY: Use the thumb to push the lower edge of the eye protector upwards gently. A 'clicking' sound can be heard and the eye protector will descend gradually from the up position automatically.

STOW: Use the thumb and push the eye protector back up gently. Stop pushing when the same 'clicking' sound is heard again. The eye protector is now locked in place.



WARNING: DO NOT PULL THE EYE PROTECTOR. This may break the mechanism causing the eye protector to stay 'deployed'. This damage is not covered by the warranty.

ADJUST WEARING HEIGHT:

Turn the screw using the hex key provided to adjust the resting position of the eye protector on the nose bridge.

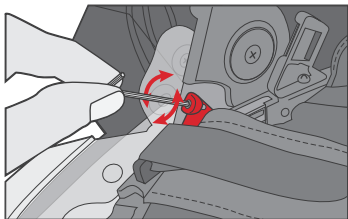

LOCK OTEP: Safety latch extended out over the edge of the eye protector to hold it in the stowed position.

UNLOCK OTEP: Safety latch rotates towards the inside.

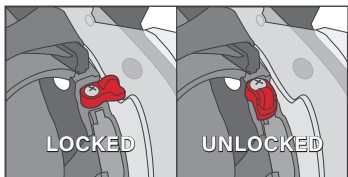

MANUAL EYE PROTECTOR INSTRUCTIONS

- **Deploy and stow the eye protector using the pull tabs by pulling down or pushing up.** This avoids touching the eye protector itself which could leave finger marks.

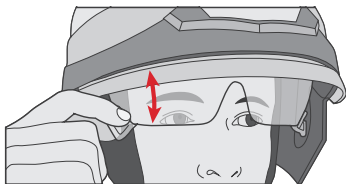

CHANGING PARTS

In most instances, your F15 will be provided fully assembled. There are some cases where you will need to install certain components, replace components that have become damaged, or remove components for cleaning and decontamination.

CHANGING PADDING AND ADDING DOWNSIZE KIT

Adding a downsize kit is recommended for smaller head sizes.

1. **Remove front comfort pad from hooks on headband.**

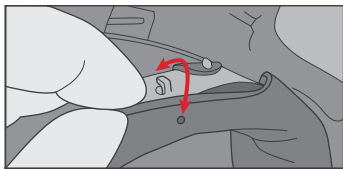

2. **Replace with a fresh comfort pad by hooking it back on the headband.**

Pull the hole in the leather further than the hook to allow it to slide into place.

3. **Remove rear comfort pad by releasing Velcro and replace with a fresh one.**

4. **Optional: Add Rear Downsize Pad** in before reattaching the rear pad.

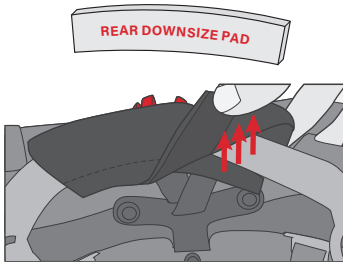

CHANGING THE NECK PROTECTOR

The neck protectors for the F15 can easily be attached and removed for cleaning and maintenance or allowing a new neck protector to be attached.

1. **The neck protector attaches at 4 points around the edge of the Chassis.**

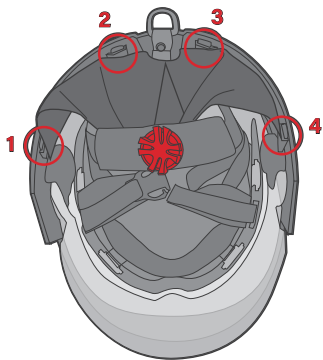

2. **The tabs pull out towards the inside of the helmet.** Hold on to the first tab and pull it down.

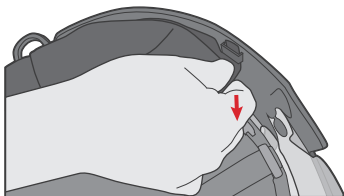

3. **Repeat for the remaining 3 tabs.** Reverse the process to reattach the neck protector.

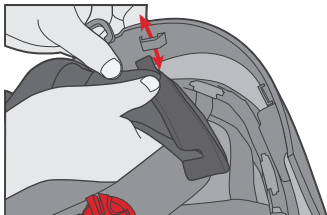

REPLACING THE EYE PROTECTOR

Please see our website www.pacifichelmets.com for an instruction video on how to replace the eye protector.

REPLACING CHINSTRAP

1. **Remove the 4 white rivets holding the front of the chinstrap on at each side.** Use a flat head screw driver to 'pop' the rivet out. There are 2 on each side.

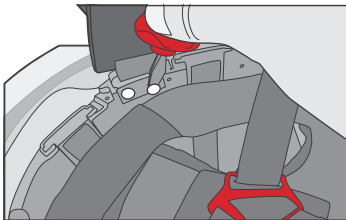

2. **Unscrew the two screws holding the Rear T-Bracket to the Chassis.**

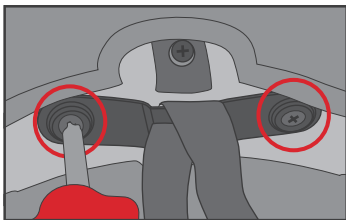

3. **Unscrew the center screw holding the Rear T-Bracket to the Liner.** Pull the chinstrap out for cleaning or replacement.

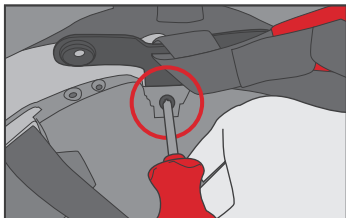

4. **Reattach the new/cleaned chinstrap,** fastening all screws and rivets to their original positions.

REPLACING FACE SHIELD

1. **Unscrew the face shield.**

There are 2 screws and 2 bosses on each side of the helmet.

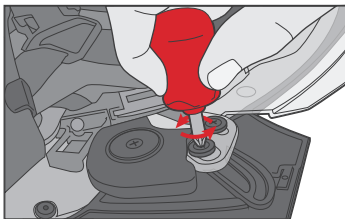

2. **Put the screws and bosses aside.**

3. **Detach the old face shield.**

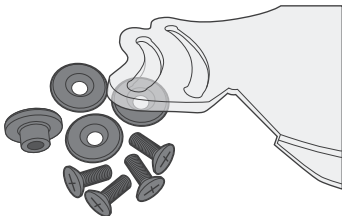

4. **Place the new face shield in the helmet.** Align the bottom of the face shield. Make sure the pin on each side goes into the rail.

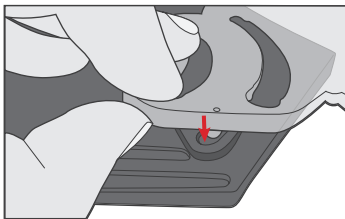

5. **Attach new face shield.** Slide the top of the face shield into place so the rails on the face shield align with the screw holes. On each side reattach the two bosses and fasten the two screws.

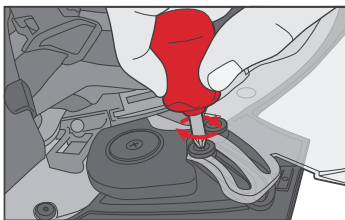

CHANGING CONFIGURABLE SIDE PLATES

You can easily change the Side Plate EOB to Side Plate SCBA to allow for use with different accessories.

1. **Unfasten the screw from the inside of the Micro-Flex Hinge.**

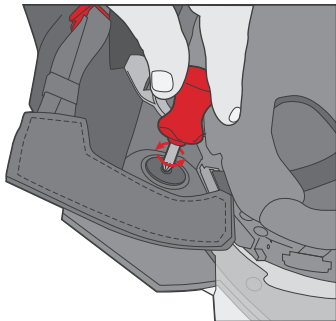

2. **Detach the Side Plate from the rear first then lever it off the slot at the side of the helmet chassis.**

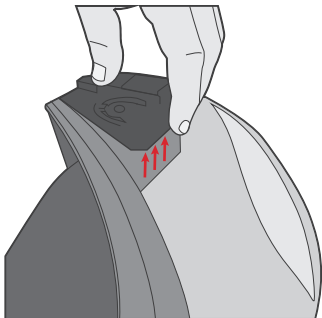

3. **Attach the new Side Plate by sliding the tab into the chassis slot and then clipping it into place.**

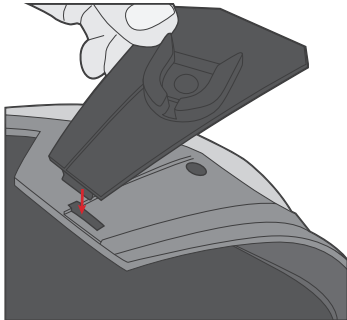

4. **Fasten the screw on the inside of the helmet.**

FITTING ACCESSORIES

FITTING A TORCH

1. **Slide the torch body into the Torch Clip.**
2. **Push the boss into the Easi On-Off Base tightly.**
3. **Swivel the Clip to check the fit is secure.**

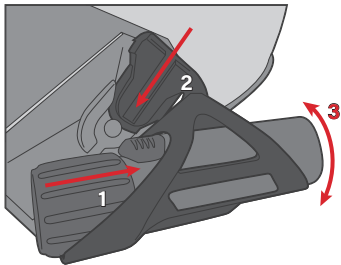

ATTACHING TITAN® COMMS BOOM MIC AND SPEAKER

1. **Secure the mic bracket onto the liner** using the screw supplied with a screw driver.
2. **Secure the comms mic** by pushing its tip into the bracket slot until you hear it clicks.
3. **Adjust the boom mic shaft** into position for optimum performance.

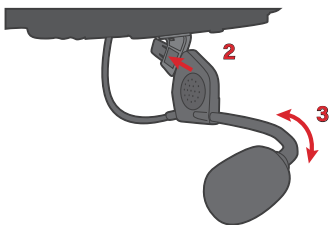
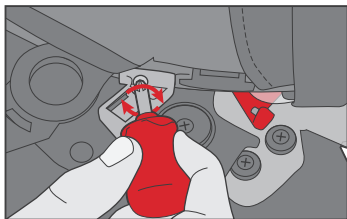

ADJUSTING SCBA/EOB SIDE PLATES

You can easily adjust the tightness of your claw BA mask when in use with the SCBA/EOB combo plate to improve the seal of your mask.

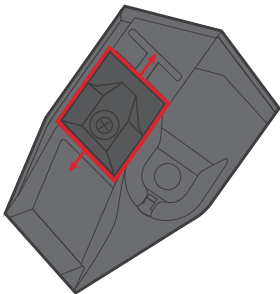

1. **The slide adjuster can be adjusted to improve the seal on your BA mask.**

2. **Unfasten the screw from the slide adjuster for the BA mask attachment.**

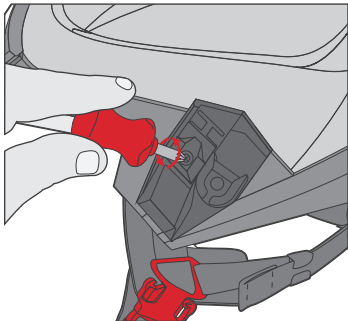

3. **Move the slide adjuster up or down the rail as required.**

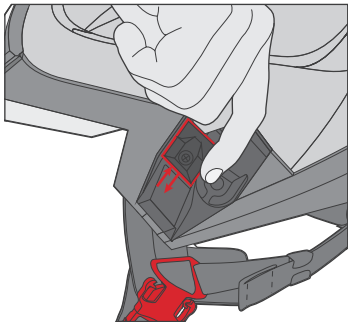

4. **Fasten the screw on slide adjuster when at the desired height.**

WEARING INSTRUCTIONS

DONNING

The following applies for proper donning of your protective helmet:

- Ensure the correct adjustment of your protective helmet as described in the section before. The adjustment should take into account if you will be wearing either a hood or an SCBA full face piece or both.
- Place your adjusted protective helmet on your head and secure the chinstrap. Never wear it without securing the chinstrap.
- Adjust all protective helmet, hood, SCBA, and garment components so that they provide a proper interface, with no gaps in protection occurring in any body position taken during use. You must deploy your neck protector completely to ensure overlap between your jacket collar, hood, and SCBA face piece. If provided and when needed, ensure that your face shield or goggles are correctly deployed.

Always check to make sure that your protective helmet, hood, jacket collar do not interfere with the seal of the SCBA full face piece on your face.

DOFFING

If your protective helmet is not contaminated:

- Remove the protective helmet in the reverse order in which you put it on.
- Inspect your protective helmet as indicated in this user information.

If your protective helmet is damaged, report this damage or other change in its condition to your supervisor or organization. Any damage or change in condition must be corrected before reusing your protection helmet. If it has become contaminated with blood, body fluids, chemicals, or hazardous substances, use protective gloves

and extreme caution in removing your helmet, and do not contact the surface of your helmet with your bare hands. Seek assistance in removing your helmet and other parts of your ensemble to minimize your exposure to any contaminants.

RECOMMENDED STORAGE PRACTICES

Always store your helmet only when it is clean, dry and free of contamination. Storing wet helmets, particularly when the suspension ribbons and neck protectors are wet, will promote growth of mildew, fungus, bacteria, or other harmful substances that can lead to skin irritation, rashes, and potential diseases or illnesses. Keep helmets away from potential contaminants such as oils, greases, or other chemical substances.

Store your helmet in a clean, well ventilated area away from direct sunlight and away from tools or other sharp objects. Do not store them with your personal belongings or in a personal living area. Do not store or transport your helmet in the window areas of apparatus and vehicles.

If your helmet comes with a rear hook on the back brim, hang it on the wall or your truck when not in use.



**CARE &
MAINTENANCE**

DETAILS OF INSPECTIONS

ROUTINE INSPECTIONS

Inspect your protective helmet prior to its first use and following every use. Prior to using it for the first time, ensure that the helmet does not have any construction flaws, is completely and properly assembled, and was not damaged when being put into service. Following every use, inspect your protective helmet for:

- Soiling or contamination
- **Shell:** physical damage such as cracks, dents, abrasions and thermal damage such as blisters, soft spots, warping, and serious discoloration
- **Neck protector or headband comfort padding:** physical damage such as rips, tears, cuts, loss of seam integrity, broken/missing stitches and thermal damage such as charring, burn holes, and melting
- **Suspension and retention systems:** damaged, broken, or missing components
- **Face shield/eye protector:** damaged, broken, or missing components, blisters, discoloration, deep scratches to the face shield/eye protector that limit visibility
- **Reflective trims:** damaged (charred or burned) or missing pieces

If these conditions exist, alert your supervisor, department, or organization to make a determination on the continued serviceability of your protective helmet.

ANNUAL INSPECTIONS





Your protective helmet is recommended to be subjected to a more thorough inspection at least every 12 months, or whenever there is a concern about its condition for continued service after a major incident.

CARE AND MAINTENANCE INSTRUCTIONS

It is important that you keep your protective helmet clean, free of contamination, and properly maintained at all times. Protective helmets that are dirty or contaminated pose significant hazards. The wearing of soiled or contaminated items can cause acute or long-term health hazards. Many contaminants can be absorbed by the skin, and some are carcinogenic. In addition, many contaminants are flammable and some are so minute that they cannot be seen with naked eyes. Do not wear your protective helmet unless it is properly cleaned and thoroughly dried.

CLEANING AND DISINFECTION PRECAUTIONS

HELMET

- Use only mild detergents with a pH range of not less than 6.0 pH and not greater than 10.5 pH as indicated on the product material safety data sheet (MSDS) or original product container. Do not use detergents or cleaning agents that are not approved by Pacific Helmets. Please contact us if in doubt.
- Never use solvents or chlorine bleach or cleaning agents that contain chlorine bleach. These substances rapidly break down some helmet materials. 
- Do not machine wash using a regular washing machine or tumble dry whole helmets. 
- Do not wash protective helmets or other protective clothing alongside personal items. 
- Do not wash protective helmets or other protective clothing alongside personal items. 
- Do not dry clean your protective helmet 

NECK PROTECTOR AND COMFORT PADDING

- Separately clean helmet neck protector and comfort padding.

- The neck protector and headband comfort padding may be machine washed and dried as instructed below. Wash and dry at temperatures below 40°C.



- Wear protective gloves and eye/face splash protection when cleaning soiled items.



- Do not wash protective helmets or other protective clothing alongside personal items.



- Do not dry clean your helmet components.



ROUTINE CLEANING AND DISINFECTION

Clean and disinfect your protective helmet after each use or whenever your helmet has become soiled. You may clean your helmet with or without the neck protector, comfort padding, and chinstrap. However it is advisable to remove them before cleaning the protective helmet.

Use the following procedures for routine cleaning by hand in a utility sink:

1. Choose a utility sink that is specifically used for cleaning protective gear; do not use a kitchen sink or other sink that is employed for personal products.
2. Optionally remove the neck protector and chinstraps and wash them separately using the instructions for machine washing.
3. Brush off any loose debris.
4. Fill the utility sink with warm water no hotter than 40°C.
5. Use a mild detergent in an amount according to the detergent supplier's instructions.
6. Scrub the helmet exterior gently using a soft-bristle brush.

7. Use only a soft cloth or sponge to clean the One-Touch eye protector and face shield surfaces.
8. Drain the sink and thoroughly rinse the helmet exterior. Conduct a second rinse if necessary.
9. Inspect the helmet and, where necessary, rewash any portions of the protective helmet that do not appear clean.
10. Dry the helmet by air drying it in a well ventilated area, but not in direct sunlight. Do not force-dry the helmet with a hair dryer, or place it over a heating duct or radiator. Forced drying may cause damage to some components in the helmet.
11. Only when all components are dry, reinstall the neck protector and comfort padding according to instructions in previous section of this guide.
12. Rinse the utility sink, following routine cleaning procedure.

OPTIONAL MACHINE WASHING OF SELECTED COMPONENTS

Washing machines and dryers may be used only for the neck protector, chinstrap and comfort padding. Do not wash your helmet components with other PPE like firefighting garments to avoid potential damage to them. Use the following procedures if machine washing and drying:

1. Choose a washing machine that is used for cleaning of protective clothing. While top-loading machines may be used, front-loading washers are preferred as these are less likely to physically damage fabrics and can be programmed for specific water levels, temperatures, and times.
2. Brush off any loose debris.

3. Pre-treat heavily soiled or spotted areas with mild detergent. Do not use soap, or caustic chemical.
4. Unless otherwise instructed, load machine to 80% of its rated capacity. Overloading will result in inefficient cleaning.
5. Use mild wash settings, a mild detergent, and warm water temperatures.
6. Following washing, remove the components and air dry as specified above, or put in a dryer on a no-heat setting.
7. Inspect the components. If necessary, rewash them or replace with new ones.

DECONTAMINATION

Proper decontamination of your protective helmet will depend on the type and extent of contamination. If your protective helmet has become contaminated with blood or body fluid, immediately isolate the helmet and inform your supervisor, department, or organization. Before reuse of your protective helmet, it must be subjected to specialized cleaning procedures that have been proven to remove contaminated fluids.

If your protective helmet has become contaminated with chemicals or other hazardous substances, immediately isolate your helmet and remove it from service, taking care not to cross-contaminate other clothing items. Immediately inform your supervisor, department, or organization. Do not wear a helmet that was contaminated until verification has been provided that it is free from contamination.

Helmet can be decontaminated in specialised washing machines which uses high pressure water jets for cleaning. Do not use washing machines which tumble the helmet inside a chamber.

REPAIR, REPLACE, AND OBSOLESCENCE INSTRUCTIONS

Note: Minor scratches or hairline cracks in the paint surface will not affect the performance of the protective helmet.

Repair if:

- The shell is permanently stained by carbon or chemical
- The painted surface slightly scratched
- There is foreign substances adhered to the shell surfaces

In these cases the shell can be restored to use by warm wet sanding to remove the stains, scratches and surface damage.

Destroy the shell and replace if:

- The shell shows signs of major laminate failure/breakage. This will either take the form of deep indentations from contact with falling objects or major crushing. It can also be seen as a “whitening” of laminate in impact area when the inside of the shell is inspected.
- The brim area has long or large crack lines, or flexes abnormally.
- The helmet has obviously suffered excess heat or burning. This includes any charring of the paint or helmet substrate. Charring is described as an actual burnt area or surface damage, which cannot be repaired by sanding or repainting.
- There is visual sign of acid or chemical residue which may have damaged the shell paint or substrate.
- The shell shows signs of distortion to its shape. This can be seen as “sagging” or “drooping” when it is compared to a new helmet. This type of damage is most unlikely in the Pacific Helmet shell, as the shell does not melt, even in extreme temperature.

Replacement of other parts:

- We recommend the Neck Protector be replaced after a maximum of 50 wash cycles, or when there are stubborn stains that cannot be removed from repeated washings.
- Replace Eye Protector once badly scratched or deformed by chemicals, heat, smoke or other pollutants.
- Replace Face Shield once badly scratched or deformed by chemicals, heat, smoke or other pollutants.

If you have any doubts about your protective helmet and its condition, bring this matter to the attention of your supervisor, department or organization immediately. Protective helmets that are no longer deemed serviceable for reasons of damage, contamination, or other unsafe condition must be disposed of in a fashion whereby the helmet cannot be reused. One example is drilling holes in the shell, removing the chinstrap and suspension system, and damaging the tabs for attaching the headband.

For general disposal of helmets, use landfills, incineration and/or other facilities that are in accordance with your municipal guidelines/regulations.

Contaminated helmets must be disposed of by your department or organization in accordance with federal, state, or local regulations.



WARRANTY

WARRANTY INFORMATION

The warranty time limits mentioned herein do not imply any form of helmet life expectancy. These time frames simply place reasonable limits on the discovery of faulty materials and workmanship and allow these to be dealt with.

The products and the relevant sub-components are supplied with varying warranties (depending on the model) from 1-6 years.

COMPONENT	WARRANTY TIME-FRAME
Shell:	up to 6-year warranty
Ear flaps/neck protectors:	up to 1-year warranty
Face shield/eye protector:	up to 2-year warranty
Internal plastic components and comfort padding:	up to 1-year warranty

PLEASE NOTE

- Damage caused to the helmet and/or components in the course of normal use is not covered by warranty.
- Many firefighting or rescue operations including training can result in damage to this helmet, which is not covered by this warranty.
- Damage resulting from careless use (e.g. dropping of helmet) and/or using helmet for anything other than its intended purpose (head protection) is not covered by warranty.
- Training personnel involved in repetitive hot fire-training will require their helmets to be replaced at frequent intervals certainly no longer than one year. This is dependent on the duration, frequency and exposure to heat and pollutants.

- All personnel involved in hot fire-training and proximity firefighting (or training) must wear their helmets with aluminized hoods over the shells when engaged in these activities.
- Follow instructions in the User Information regarding regular checks on this helmet and when making repair/replace decisions.
- Components are available as spare parts.



TECHNICAL INFORMATION

CERTIFICATION AND DISTRIBUTORS INFORMATION

This helmet is certified to the following standards:

- AS/NZS 4067:2012 with AS/NZS 1337.1:2010
- EN443:2008 with EN14458:2004
- NFPA 1971:2018 and NFPA 1951:2020 with ANSI Z87.1:2015

Depending on the standard, the helmet might have different features or ancillary material specifically needed to comply with the respective standard requirements. It is paramount that you specify the standard you want your helmet certified to when putting in a purchase order.

CERTIFICATION

Certification for our helmets is completed by the following certification bodies. Contact your Pacific Helmets distributor for a copy of the certificate.

AS/NZS and NFPA: BSI Group ANZ Pty Ltd
Suite 2, 123 Whitehorse Road
Balwyn, VIC 3103, AUSTRALIA

CE mark: BTTG Testing & Certification Ltd
(NB number 0338)
Unit 14, Wheel Forge Way,
Trafford Park, Manchester
M17 1EH, UNITED KINGDOM

M.E. Industrial Products
(Authorised Representative)
41 Ramsey Gardens,
Romford, ESSEX, RM3 7NT, UK



AUTHORIZED DISTRIBUTORS

Please visit our website www.pacifichelmets.com for up-to-date distributor details.

STANDARDS INFORMATION

AS/NZS4067:2012

Protective helmets for structural firefighting

- No helmet can protect the wearer against all possible types of impacts
- Do not modify or remove parts or add accessories which are not approved by the manufacturer. Replace harness and other components as recommended by manufacturer.
- Helmet and face shield may be seriously damaged by certain substances. Manufacturer's instructions should be followed for cleaning and maintenance.
- This helmet must be properly adjusted and secured to the head, with all components in place, to provide the designed level of protection.
- For maximum retention, the helmet must fit firmly on the head, and all retention straps must be securely fastened.
- No attachments should be added nor any alterations made to the helmet except those recommended by the helmet manufacturer.
- If replacement of any components of the harness is necessary, the complete harness should be replaced.

EN443:2008 / CE / MED

Helmets for firefighting in buildings and other structures, EN443:2008, complies with the PPE Regulation (CE), and Marine Equipment Directive (MED)

Explanation of the symbols shown on labels fitted inside the helmets.

Year of manufacture	e.g. 18 (2018)
Surface electrical insulation test	E2, E3

Resistance to liquid chemical	C
Low temperature classification, -30°C	***

INSTRUCTIONS OR RECOMMENDATIONS

- Size selection – all helmets are adjustable to sizes between 52-65cm, with downsize padding kits available to adjust sizes between 52-56cm.
- Mass – firefighting helmets may vary in weight depending on models, specifications and accessories but will typically be between 1.5-1.7kg.
- Use – helmets are designed for structural firefighting in both land and marine environments.
- Cleaning and disinfection – please see Care and Maintenance Information section.
- Maintenance and servicing – please see Care and Maintenance Information section.
- Storage and transportation – store helmet in dry ambient conditions when not in use. For marine use, keep the helmet dry and away from moisture or liquid like seawater that may deteriorate the components prematurely. Always keep the helmet in its carry bag.
- Obsolescence – the helmet can be expected to remain in service for up to 25 years, when it is not damaged during use.
- Inspections (especially applicable to the Marine Equipment Directive) – helmets are to be inspected at least monthly or according to the interval defined by each vessel. On most merchant ships this should take place during routine fire and/or emergency drills. Check the exterior and cradle of the helmet for wear and tear, rust, or any signs of deterioration. If in doubt, please

go to Repair/Replace instruction/Obsolescence and Maintenance information sections of this user information.

The length of the usable life of this helmet will be affected by the type(s) of material used in its construction and the environments in which the helmet is used and stored. Recommendations on this topic should be sought from the manufacturer.

Details of additional approved accessory devices can be provided. This includes Easi On-Off Bases, torches, torch clips, face shields, eye protectors, and neck protectors.

List of chemicals against which the helmet has been tested.

- 30% sulphuric acid, 10% sodium hydroxide, p-Xylene, Butan-1-ol, n-Heptane.

NFPA1971:2018 AND NFPA1951:2020

Structural and proximity firefighting – NFPA1971:2018 edition
Technical rescue incidents – NFPA1951:2020 edition

SAFETY CONSIDERATIONS

- No helmet can protect the wearer against all possible types of impacts. The capacity of the helmets designed level of protection could be exceeded in some foreseeable perilous emergency services incidents.
- For maximum protection, the helmet must fit firmly on the head and all retention straps must be securely fastened.
- No attachments should be added or alterations made to the helmet except those recommended by the helmet manufacturer. Do not remove parts from the helmet without replacing them with genuine replacements.
- The helmet is designed to absorb shock by partial destruction of the shell and liner. This damage may not be visible. Therefore, if subjected to a severe blow, the helmet should be returned to the

fire department equipment service center or your local helmet distributor for inspection or replacement.

HELMET MARKING RECOMMENDATIONS AND RESTRICTIONS.

Subject to the restrictions on modification or drilling holes, most self-adhesive labels and other forms of external marking can be applied to the shell.

PERFORMANCE PROPERTIES AND PRECAUTIONS

The helmet user is cautioned that most of the performance properties of the helmet cannot be safely tested by the user in the field. Because helmets can be damaged, they should not be abused. They should be kept free from abrasions, nicks and should not be dropped, sat on, thrown, or used as supports. This applied especially to helmets that are intended to afford protection against electrical hazards.

Proper use consistent with NFPA1500, *Standard on Fire Department Occupational Safety, Health, and Wellness Program*, and 29 CFR 1910.132, "Personal Protection Equipment" should be adhered to at all time.

LIMITATIONS OF USE

- **NFPA1971:2018 edition, Structural and Proximity Firefighting**
These helmets are designed for use in general urban/military/marine firefighting and rescue/paramedic operations.
- **NFPA1951:2020 edition, Technical Rescue Incidents**
These helmets are designed for use in general urban/military/police rescue and paramedic operations.



PACIFIC HELMETS NZ LTD

P.O. BOX 866 / 315 HEADS ROAD
WANGANUI 4501, NEW ZEALAND

PHONE: +64 6 344 5019

FAX: +64 6 344 5376

SALES@PACIFICHELMETS.COM

WWW.PACIFICHELMETS.COM

F15 JUNE 2020 ENGLISH EDITION

A122006



This user information guide is to be removed from the helmet only by the end user. Please read carefully all instructions and warnings before use. Failure to follow these instructions could result in death or serious injury.